



PM-100



PM-200

Owner's Manual

PERSONAL MONITOR

PM-100

PM-200

Dedicated V-Drums Personal Monitor

The PM-100/PM-200 is a powered monitor specially matched to Roland's "V-Drums" drum sound modules.

Equipped with a dedicated V-Drums input, this monitor brings out all of the "V-Drums" sound.

- **High quality and powerful sound**

A newly developed two-way speaker is bi-amped to deliver clear and powerful sound.

- **Multifunctional inputs**

LINE INPUT is provided. You can connect and play back sources in addition to a drum sound module, such as an audio player or electronic musical instrument.

- **Body designed for excellent portability**



The monitor features a bar-type handle to make carrying easier.

Before using this unit, carefully read "IMPORTANT SAFETY INSTRUCTIONS" (inside front cover), "USING THE UNIT SAFELY" (p. 2), and "IMPORTANT NOTES" (p. 3). After reading, keep the document(s) where it will be available for immediate reference.



USING THE UNIT SAFELY

INSTRUCTIONS FOR THE PREVENTION OF FIRE, ELECTRIC SHOCK, OR INJURY TO PERSONS

About ⚠ WARNING and ⚠ CAUTION Notices

 WARNING	Used for instructions intended to alert the user to the risk of death or severe injury should the unit be used improperly.
 CAUTION	Used for instructions intended to alert the user to the risk of injury or material damage should the unit be used improperly. * Material damage refers to damage or other adverse effects caused with respect to the home and all its furnishings, as well to domestic animals or pets.

About the Symbols

	The ⚠ symbol alerts the user to important instructions or warnings. The specific meaning of the symbol is determined by the design contained within the triangle. In the case of the symbol at left, it is used for general cautions, warnings, or alerts to danger.
	The ⚡ symbol alerts the user to items that must never be carried out (are forbidden). The specific thing that must not be done is indicated by the design contained within the circle. In the case of the symbol at left, it means that the unit must never be disassembled.
	The ⏻ symbol alerts the user to things that must be carried out. The specific thing that must be done is indicated by the design contained within the circle. In the case of the symbol at left, it means that the power-cord plug must be unplugged from the outlet.

ALWAYS OBSERVE THE FOLLOWING

WARNING

Make sure that the power cord is grounded

Connect mains plug of this model to a mains socket outlet with a protective earthing connection.



To completely turn off power to the unit, pull out the plug from the outlet

Even with the power switch turned off, this unit is not completely separated from its main source of power. When the power needs to be completely turned off, turn off the power switch on the unit, then pull out the plug from the outlet. For this reason, the outlet into which you choose to connect the power cord's plug should be one that is within easy reach and readily accessible.



Secure a sufficient amount of space at the setup location

Since this unit normally emits a slight amount of heat, make sure to secure sufficient space around it, as shown below.

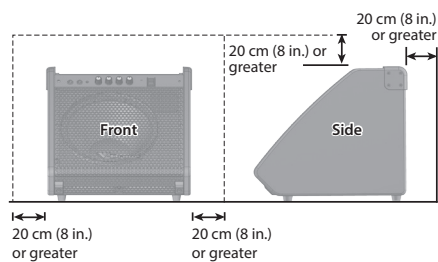

Do not disassemble or modify by yourself

Do not carry out anything unless you are instructed to do so in the owner's manual. Otherwise, you risk causing malfunction.



Do not repair or replace parts by yourself

Refer all servicing to your retailer, the nearest Roland Service Center, or an authorized Roland distributor, as listed on the "Information."



WARNING

Do not use or store in the following types of locations

- Subject to temperature extremes (e.g., direct sunlight in an enclosed vehicle, near a heating duct, on top of heat-generating equipment); or are
- Damp (e.g., baths, washrooms, on wet floors); or are
- Exposed to steam or smoke; or are
- Subject to salt exposure; or are
- Exposed to rain; or are
- Dusty or sandy; or are
- Subject to high levels of vibration and shakiness; or are
- Placed in a poorly ventilated location.



Do not place in an unstable location

Otherwise, you risk injury as the result of the unit toppling over or dropping down.



Connect the power cord to an outlet of the correct voltage

The unit should be connected to a power supply only of the type described as marked on the rear side of unit.



Use only the supplied power cord

Use only the attached power cord. Also, the supplied power cord must not be used with any other device.



Do not bend the power cord or place heavy objects on it

Otherwise, fire or electric shock may result.



Avoid extended use at high volume

Use of the unit at high volume for extended periods of time may cause hearing loss. If you ever experience any hearing loss or ringing in the ears, you should immediately stop using the unit and consult a specialized physician.



Do not allow foreign objects or liquids to enter unit; never place containers with liquid on unit

Do not place containers containing liquid (e.g., flower vases) on this product. Never allow foreign objects (e.g., flammable objects, coins, wires) or liquids (e.g., water or juice) to enter this product. Doing so may cause short circuits, faulty operation, or other malfunctions.



WARNING

Turn off the unit if an abnormality or malfunction occurs

Immediately turn the unit off, remove the power cord from the outlet, and request servicing by your retailer, the nearest Roland Service Center, or an authorized Roland distributor, as listed on the "Information" when:

- The power cord has been damaged; or
- If smoke or unusual odor occurs; or
- Objects have fallen into, or liquid has been spilled onto the unit; or
- The unit has been exposed to rain (or otherwise has become wet); or
- The unit does not appear to operate normally or exhibits a marked change in performance.



Be cautious to protect children from injury

Always make sure that an adult is on hand to provide supervision and guidance when using the unit in places where children are present, or when a child will be using the unit.



Do not drop or subject to strong impact

Otherwise, you risk causing damage or malfunction.



Do not share an outlet with an unreasonable number of other devices

Otherwise, you risk overheating or fire.



Do not use overseas

Before using the unit in overseas, consult with your retailer, the nearest Roland Service Center, or an authorized Roland distributor, as listed on the "Information."



Don't place burning objects on the unit

Don't place any burning object (such as a candle) on the unit.



Be aware of weather conditions

Use the apparatus in moderate climates.



CAUTION

When disconnecting the power cord, grasp it by the plug

To prevent conductor damage, always grasp the power cord by its plug when disconnecting it. 

Periodically clean the power plug

An accumulation of dust or foreign objects between the power plug and the power outlet can lead to fire or electric shock. 

At regular intervals, be sure to pull out the power plug, and using a dry cloth, wipe away any dust or foreign objects that may have accumulated.

Disconnect the power plug whenever the unit will not be used for an extended period of time

Fire may result in the unlikely event that a breakdown occurs. 

Route all power cords and cables in such a way as to prevent them from getting entangled

Injury could result if someone were to trip on a cable and cause the unit to fall or topple. 

CAUTION

Avoid climbing on top of the unit, or placing heavy objects on it

Otherwise, you risk injury as the result of the unit toppling over or dropping down. 

Never connect/disconnect a power plug if your hands are wet

Otherwise, you could receive an electric shock. 

Disconnect all cords/cables before moving the unit

Before moving the unit, disconnect the power plug from the outlet, and pull out all cords from external devices. 

Before cleaning the unit, disconnect the power plug from the outlet

If the power plug is not removed from the outlet, you risk receiving an electric shock. 

CAUTION

Whenever there is a threat of lightning, disconnect the power plug from the outlet

If the power plug is not removed from the outlet, you risk causing malfunction or receiving an electric shock. 

Take care not to get burned

The front panel and rear panel may become hot, so take care to avoid burns. 

Do not remove the speaker grille and speaker

Do not remove the speaker grille and speaker by any means. Speaker is not user replaceable. Shock hazardous voltages and currents are present inside the enclosure. 

IMPORTANT NOTES

Power Supply

- Do not connect this unit to same electrical outlet that is being used by an electrical appliance that is controlled by an inverter or a motor (such as a refrigerator, washing machine, microwave oven, or air conditioner). Depending on the way in which the electrical appliance is used, power supply noise may cause this unit to malfunction or may produce audible noise. If it is not practical to use a separate electrical outlet, connect a power supply noise filter between this unit and the electrical outlet.

Placement

- Using the unit near power amplifiers (or other equipment containing large power transformers) may induce hum. To alleviate the problem, change the orientation of this unit; or move it farther away from the source of interference.
- This unit may interfere with radio and television reception. Do not use this unit in the vicinity of such receivers.
- Noise may be produced if wireless communications devices, such as cell phones, are operated in the vicinity of this unit. Such noise could occur when receiving or initiating a call, or while conversing. Should you experience such problems, you should relocate such wireless devices so they are at a greater distance from this unit, or switch them off.
- When moved from one location to another where the temperature and/or humidity is very different, water droplets (condensation) may form inside the unit. Damage or malfunction may result if you attempt to use the unit in this condition. Therefore, before using the unit, you must allow it to stand for several hours, until the condensation has completely evaporated.
- Depending on the material and temperature of the surface on which you place the unit, its rubber feet may discolor or mar the surface.
- Do not place containers or anything else containing liquid on top of this unit. Also, whenever any liquid has been spilled on the surface of this unit, be sure to promptly wipe it away using a soft, dry cloth.

Maintenance

- Never use benzine, thinners, alcohol or solvents of any kind, to avoid the possibility of discoloration and/or deformation.

Additional Precautions

- Use a reasonable amount of care when using the unit's buttons, sliders, or other controls; and when using its jacks and connectors. Rough handling can lead to malfunctions.
- When disconnecting all cables, grasp the connector itself—never pull on the cable. This way you will avoid causing shorts, or damage to the cable's internal elements.
- A small amount of heat will radiate from the unit during normal operation.
- To avoid disturbing others nearby, try to keep the unit's volume at reasonable levels.
- Do not use connection cables that contain a built-in resistor.

Intellectual Property Right

- Roland and V-Drums are either registered trademarks or trademarks of Roland Corporation in the United States and/or other countries.
- Company names and product names appearing in this document are registered trademarks or trademarks of their respective owners.

Panel Descriptions

Front Panel

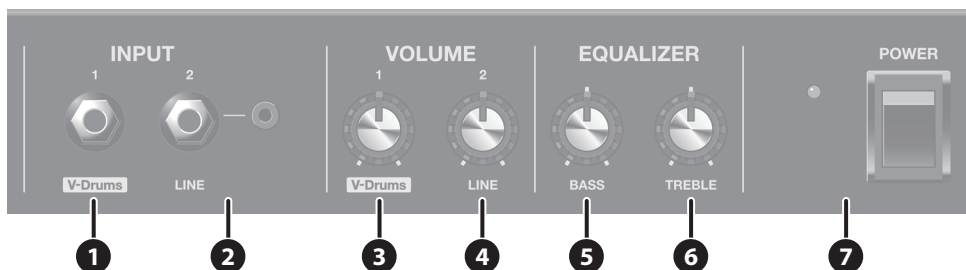

1 V-drums INPUT jack

Connect the drum sound module to this jack.

2 LINE INPUT jacks

Connect an audio player or electronic musical instrument here, and hear it along with the drums.

Both stereo phone 1/4" and stereo mini 1/8" jacks are provided, and can be used simultaneously.

Pin assignment of INPUT (V-Drums, LINE) jacks

Both mono and stereo are supported.



* This accepts 1/4" stereo phone plug. However, the speaker is mono.

3 [V-Drums VOLUME] knob

Adjusts the volume of the device connected to the V-Drums INPUT jack.

4 [LINE VOLUME] knob

Adjusts the volume of the device connected to the LINE INPUT jacks.

5 [BASS] knob

Adjusts the level of the Low frequency.

6 [TREBLE] knob

Adjusts the level of the High frequency.

7 [POWER] switch/POWER indicator

This switch turns the power on/off.

When the power is on, the indicator will be lit.

Rear Panel

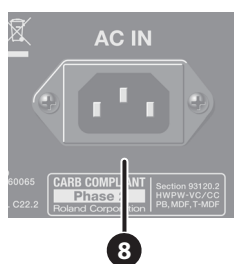

8 AC IN jack

Connect the included Power cord here. Plug it firmly in, so that the cable does not accidentally become disconnected.

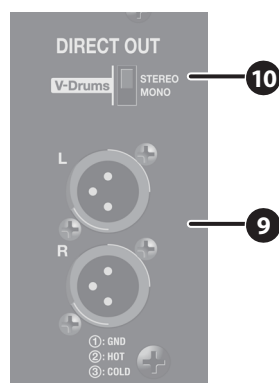

DIRECT OUT (PM-200 only)

9 DIRECT OUT L, R connectors

Connect this to your PA system or recorder.

The signals that are input to the INPUT jacks (V-Drums, LINE) are output without change.

Pin assignment of DIRECT OUT connectors

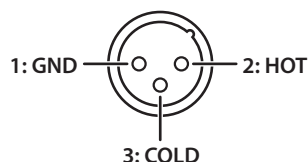

10 [DIRECT OUT] switch

When the signal that is input to the V-Drums INPUT jack is output from the DIRECT OUT jacks, this switch selects whether the output is stereo or mono.

* This switch does not affect the signal that is input to the LINE INPUT jacks.

	When the input is stereo	When the input is mono
STEREO	Stereo output	Signal (mono) is output from the L channel only
MONO	Same signal (mono) is output from the L and R channels	

Connections

* To prevent malfunction and equipment failure, always turn down the volume, and turn off all the units before making any connections.

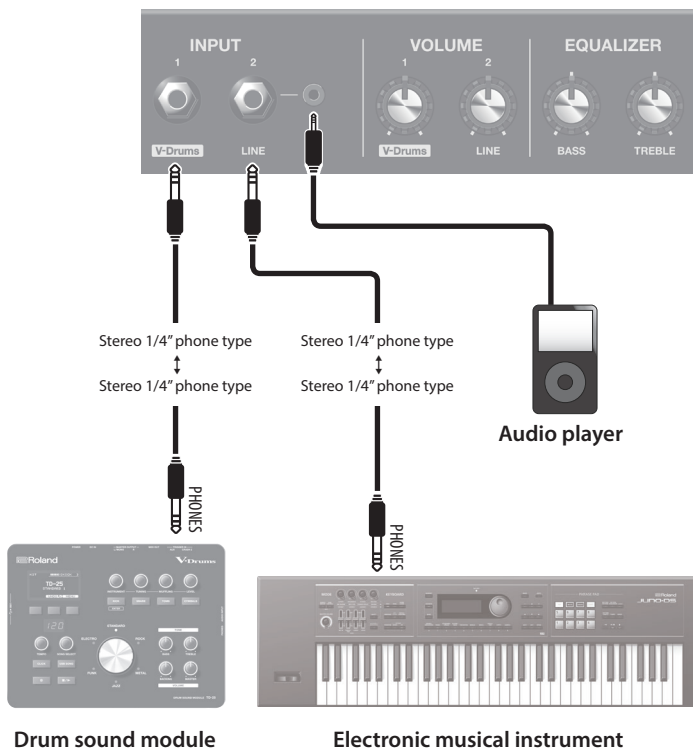

You can also connect your equipment to the INPUT jacks in the following ways.

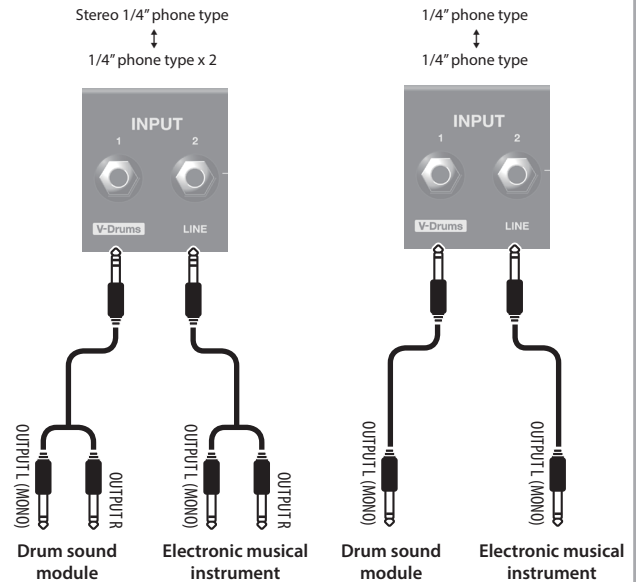

Turning the Power On/Off

- * Once everything is properly connected, be sure to follow the procedure below to turn on their power. If you turn on equipment in the wrong order, you risk causing malfunction or equipment failure.
- * Before turning the unit on/off, always be sure to turn the volume down. Even with the volume turned down, you might hear some sound when switching the unit on/off. However, this is normal and does not indicate a malfunction.

Turning the power on

1. Make sure that all volume controls on this unit and connected devices are set to minimum.
2. Turn on the devices connected to the V-Drums INPUT jack and LINE INPUT jacks.
3. Turn on this unit's [POWER] switch.
4. Turn on the devices connected to the DIRECT OUT jacks. (PM-200 only)
5. Adjust the volume levels for the devices.

- * The input sensitivity of this unit has been set somewhat high, to allow use with drum sound modules having relatively low output levels. But if you connect a sound module with a high output level (such as the TD series), distortion may occur if you turn the volume level up too much. Be careful.

Turning the power off

6. Turn down the volume of all equipment, and then power-off the units in the opposite order from when turning them on.

- * If you need to turn off the power completely, first turn off the unit, then unplug the power cord from the power outlet. Refer to "To completely turn off power to the unit, pull out the plug from the outlet" (p. 2).

Main Specifications

Roland PM-100, PM-200: Personal Monitor

	PM-100	PM-200
Rated Power Output	80 W	180 W
Nominal Input Level	V-Drums INPUT: -6 dBu (10 kΩ) LINE INPUT: -6 dBu (10 kΩ)	
Speakers	25 cm (10 inches) Woofer x 1, 5 cm (2 inches) Tweeter x 1	30 cm (12 inches) Woofer x 1, Horn Tweeter x 1
Controls	POWER switch V-Drums VOLUME knob LINE INPUT VOLUME knob BASS knob TREBLE knob	POWER switch V-Drums VOLUME knob LINE INPUT VOLUME knob BASS knob TREBLE knob DIRECT OUT switch
Indicator	POWER	
Connectors	V-Drums INPUT jack: Stereo 1/4-inch phone type LINE INPUT jack: Stereo 1/4-inch phone type, Stereo miniature phone type AC IN jack	V-Drums INPUT jack: Stereo 1/4-inch phone type LINE INPUT jack: Stereo 1/4-inch phone type, Stereo miniature phone type DIRECT OUT connector: XLR type AC IN jack
Power Consumption	36 W	64 W
Dimensions	388 (W) x 407 (D) x 354 (H) mm 15-5/16 (W) x 16-1/16 (D) x 13-15/16 (H) inches	458 (W) x 469 (D) x 420 (H) mm 18-1/16 (W) x 18-1/2 (D) x 16-9/16 (H) inches
Weight	13.5 kg 29 lbs 13 oz	21.0 kg 46 lbs 5 oz
Accessories	Owner's manual Power cord	

* 0 dBu = 0.775 Vrms

* This document explains the specifications of the product at the time that the document was issued. For the latest information, refer to the Roland website.

Block Diagram

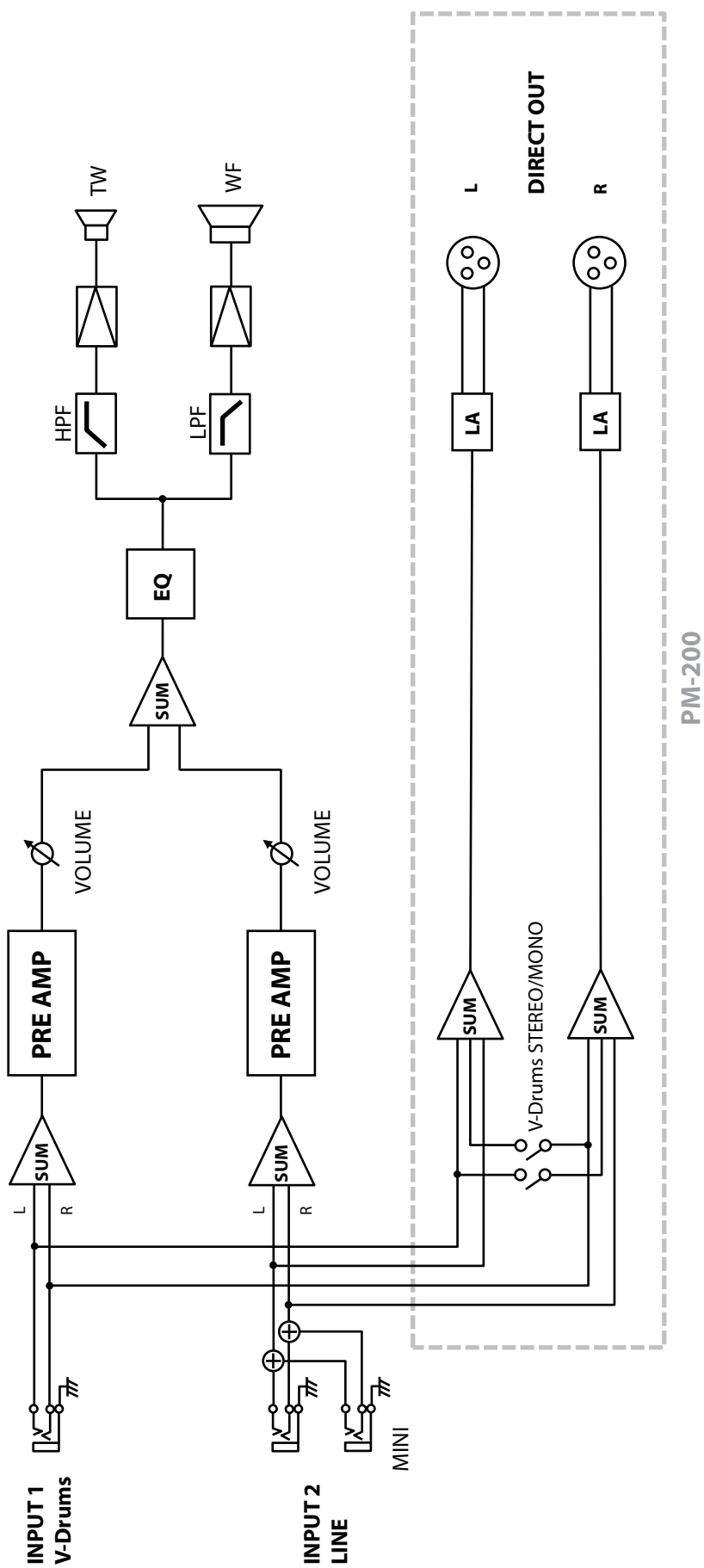

 **Roland**